

Smart Sensors
ZS Series

Non-procedural Communication

Command Reference

OMRON

Introduction

Thank you for purchasing the ZS Series.

This manual provides reference information on non-procedural communication commands for ZS Series.

This manual provides information for the following models and versions.

Model	Firmware Version
ZS-LDC	v2.000 or later
ZS-HLDC	v1.000 or later
ZS-MDC	v2.000 or later
ZS-DSU	v2.000 or later

Different firmware versions may cause communication errors, unintended setting overwrite, and damages on the controller. Please make sure to use the controller with the correct software version.

If your software version is not listed in the table above, please update the software using the SmartMonitorZS firmware update software, such as WarpEngineZS, to match the software version.

When using the ZS Series, be sure to observe the following:

- The ZS Series must be operated by personnel knowledgeable in electrical engineering.
- To ensure correct use, please read this manual thoroughly to deepen your understanding of the product.
- Please keep this manual in a safe place so that it can be referred to whenever necessary.

Contents

Setting the Communication Specifications	2
Format.....	3
List of Non-procedural Commands	4
List of Parameters (ZS-LDC)	7
List of Parameters (ZS-HLDC)	12
List of Parameters (ZS-MDC)	20
List of Parameters (ZS-DSU)	25
FLOWDATA Reference	30
Capturing Image Data	36
Example of Usage	38
Revision History	42

Setting the Communication Specifications

Change the settings of the controller communication specifications for non-procedural communication with the external device.



CHECK!

Use USB cable or RS-232C cable to connect ZS Series controllers to external devices. For USB cable connection, install Smart Monitor ZS and USB driver beforehand. After installing Smart Monitor ZS, USB ports are recognized as standard COM ports, and communication is achieved as with the RS-232C. (Setting the communication specifications including baud rate is not necessary.) For details on how to connect cable, refer to the User's Manual for each controller.

- 1. Set the mode switch to "FUN".**
- 2. Select [System] - [Communication] - [Mode] menu.**
- 3. Select [non-procedural].**
- 4. For RS-232C cable connection, select [System] - [Communication] - [RS-232C] menu to set the appropriate communication specifications for the external device.**
- 5. Save the settings.**



CHECK!

If you are connecting multiple controllers, set all controllers other than ZS-HLDC to [non-procedural]. Note that the communication with SmartMonitor ZS is not available in [non-procedural] mode. If you want to communicate with SmartMonitor ZS, reset to [CompoWay/F] communication.

Format

The format of non-procedural commands are as follows:

Example: A command to acquire a measured value MEASURE command

* Each character is output as an ASCII code (except for FLOWDATA response).

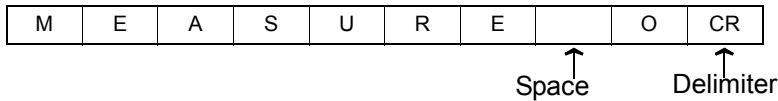

The format of returned values changes depending on the command.

For the description of each command, refer to "List of Non-procedural Commands" section.

•MEASURE / M / DATAGET

The returned value consists of right aligned 11 characters and a delimiter. The unit is nm for a displacement value. Shortfalls of the characters are filled with spaces from the left.

Example: The returned value is -30.719923 mm.

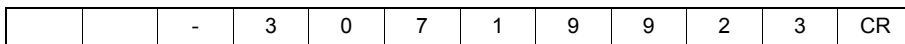

•BANKGET command

The returned value is output as 1 character bank No.

Example: The bank No. is 2.



•VERGET command

The returned value is output in the following format:

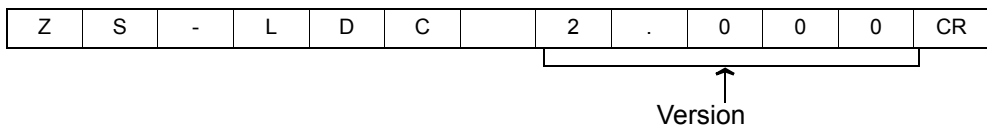

•Other commands

Either OK or ER is returned according to the result of the command. The command was executed properly:

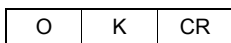

The command was not executed properly or the setting was NG:

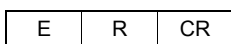

The delimiter can be selected from the following three types.

CR/LF/CR+LF



List of Non-procedural Commands

Command name	Format	Returned value	Description	Support			
				LDC	HLDC	MDC	DSU
MEASURE	MEASURE <Task No.> <delimiter>	<measured value> <delimiter>	Acquires a measured value. If <Task No.> is omitted, it acquires the displayed measured value.	Yes	Yes	Yes	Yes
M	M <Task No.> <delimiter>	<measured value> <delimiter>	Same as MEASURE command.	Yes	Yes	Yes	Yes
DATAGET	DATAGET <Unit No.> <Data No.> <delimiter>	<Data> <delimiter>	Acquires measurement data or setting data of the processing unit. * For details of numbers, refer to "List of Parameters."  p.7	Yes	Yes	Yes	Yes
DATASET	DATASET <Unit No.> <Data No.> <Setting value> <delimiter>	OK <delimiter> ER <delimiter>	Changes setting data of the processing unit. * For details of numbers, refer to "List of Parameters."  p.7	Yes	Yes	Yes	Yes
BANKGET	BANKGET<delimiter>	<Bank No.> <delimiter>	Acquires the current bank No.	Yes	Yes	Yes	Yes
BANKSET	BANKSET<Bank No.> <delimiter>	OK <delimiter> ER <delimiter>	Switches to the designated bank No.	Yes	Yes	Yes	Yes
ZERORST	ZERORST <Task No.> <delimiter>	OK <delimiter> ER <delimiter>	Executes a zero-reset. If <Task No.> is omitted, it executes on the task currently displayed as a result. If <Task No.> is set to 4, it executes on all the tasks.	Yes	Yes	Yes	No
ZEROCLR	ZEROCLR <Task No.> <delimiter>	OK <delimiter> ER <delimiter>	Cancels a zero-reset. If <Task No.> is omitted, it executes on the task currently displayed as a result. If <Task No.> is set to 4, it executes on all the tasks.	Yes	Yes	Yes	No
DATASAVE	DATASAVE <delimiter>	OK <delimiter> ER <delimiter>	Saves all the bank data on the flash memory of the controller.	Yes	Yes	Yes	Yes

List of Non-procedural Commands

Command name	Format	Returned value	Description	Support			
				LDC	HLDC	MDC	DSU
VERGET	VERGET<delimiter>	<Type/Version> <delimiter>	Acquires version information of the system. Example: ZS-LDC 1.100<delimiter>	Yes	Yes	Yes	Yes
BKMC2CTR	BKMC2CTR <Bank file No.> <Target controller CH> <delimiter>	OK <delimiter> ER <delimiter>	Sends bank files stored on a memory card to the specified bank of the specified controller. Example: To transfer the bank data of the bank file No. 2 on the memory card to the controller of 1CH, enter the following command. BKMC2CTR 2 1<delimiter>	No	No	No	Yes
BKCTR2MC	BKCTR2MC <Bank file No.> <Target controller CH> <Target Bank> <delimiter>	OK <delimiter> ER <delimiter>	Sends the specified bank of the controller of the specified CH to the memory card. Example: To transfer the bank data on the Bank 3 of 2CH to the Bank file No. 10 on the memory card, enter the following command. BKCTR2MC 10 2 3<delimiter>	No	No	No	Yes
FLOWDATA	FLOWDATA <delimiter>	OK <delimiter> ER <delimiter>	Used to acquire measurement data at the shortest intervals possible. For details, refer to "FLOWDATA Reference."  p.30	Yes (*1)	Yes (*1)	Yes (*1)	No
CFLOGGET	CFLOGGET <Logging No.> <delimiter>	<measurement value> <delimiter> : <measurement value> <delimiter> Or, if the file with the specified logging No. does not exist, the return value is as follows: NO FILE <delimiter> If memory card is not inserted, the return value is as follows:	Obtains the measurement value from the logging file with the specified No. Enter 3-digits number to the logging No. Examples: For the Logging No. 1 ⇒ 001 For the Logging No. 11 ⇒ 011	No	No	No	Yes (*2)

List of Non-procedural Commands

Command name	Format	Returned value	Description	Support			
				LDC	HLDC	MDC	DSU
CFIMGGET	CFIMGGET <Group No.> <Logging No.> <delimiter>	(Omitted)	Capture the specified image data. For details, refer to "Capturing Image Data."  p.36	No	No	No	Yes (*2)
CFDATGET	CFDATGET <Group No.> <delimiter>	<measurement value> <delimiter> : <measurement value> <delimiter>	Obtains the measurement value from the logging file for the image data in the specified group. For details, refer to "Capturing Image Data."  p.36	No	No	No	Yes (*2)

*1 It is available when USB cable connection is used.

*2 For ZS-DSU Ver 2.00 or later. It is available when USB cable connection is used.

* Specifying CH

In case other than ZS-HLDC

Specify <CH No.> before <delimiter>. If <CH No.> is omitted, the command operates on the CH that received it.

Example: To acquire the result for TASK2 of the controller of 2CH,
M 1 2 <delimiter>

In case of ZS-HLDC

Specify #XX at the beginning of the command.

If the CH No. is 1, specify #01. (Be sure to note double digits.)

If <CH No.> is omitted, the command operates on the CH that received it.

Example: To acquire the result for TASK2 of the controller of 2CH,
#02 M 1 <delimiter>

* Specifying the node

Specify @xx at the beginning of the command.

If the node No. is 1, specify @01. (Be sure to note double digits.)

If the node No. is omitted, the command operates on the node that received it.

To specify, the node and CH together in case of ZS-HLDC, specify @XX # △△ at the head of the command.

* Format of a returned value

A returned value for MEASURE,M,DATAGET,CFLOGGET,CFDATGET is the right aligned 11 characters.

* Upper case and lower case characters

For alphabetic, only upper case characters are accepted.

* Task No.

Omit <Task No.> when issuing a command for ZS-LDC.

Task Nos are assigned as follows: 0: TASK1 1: TASK2 2: TASK3 3: TASK4.

List of Parameters (ZS-LDC)

The following parameters can be obtained or set by DATASET or DATAGET command:

Unit No.	Data No.	Parameter	Setting range/Output range	Others
0	0	Measurement mode	0: STANDARD 1: HI-RESO 2: HI-SPEED 3: HI-SENS 4: CUSTOM	
	12	Start position of area 1	0 to 639 (pix)	
	14	End position of area 1	0 to 639 (pix)	
	24	Start position of area 2	0 to 639 (pix)	
	26	End position of area 2	0 to 639 (pix)	
	18	Exposure time	2 to 200 (1 div: 0.1ms)	Parameters for CUSTOM mode
	19	Number of additional lines	1 to 200	
	20	Line skipping	0: OFF 1: ON	
	32	Meas. Cycle	112 to 20000 (us)	
1	0	Head installation	0: DIFFUSE 1: REGULAR	
2	0	LD power mode	0: Auto 1: Auto-scale 2: Fixed	
	2	Surface to be controlled for light amount	0: Peak 1: 1st surface 2: 2nd surface 3: 3rd surface	
	13	Lower limit of LD power	0 to 800 (1 div: 0.1%)	
	14	Upper limit of LD power	0 to 800 (1 div: 0.1%)	
	37	Incident level (1st surface)	0 to 4095 (tone)	
	38	Incident level (2nd surface)	0 to 4095 (tone)	
	39	Incident level (3rd surface)	0 to 4095 (tone)	
3	0	Measurement object	0: NORMAL 1: PCB 2: MIRROR 3: GLASS 4: THICK 5: GAP 6: CUSTOM	
	1	Glass thickness/Gap mode	0: Normal 1: Film/Else	
	2	Glass thickness/Gap mode	0: STOP 1: MOVE	

List of Parameters (ZS-LDC)

Unit No.	Data No.	Parameter	Setting range/Output range	Others
3	3	Image smoothing level	0: None 1: Filter size 2 2: Filter size 4 3: Filter size 8 4: Filter size 16	
	4	Background removing level before addition	0 to 255 (tone)	
	5	Background removing level after addition	0 to 4095 (tone)	
	6	Edge threshold	0: 0% 1: 12.5% 2: 25% 3: 37.5% 4: 50% 5: 62.5% 6: 75% 7: 87.5%	
4	0	Mutual interference prevention mode	0: OFF 1: ON	
	1	Mutual interference prevention timing	0: Timing A 1: Timing B	
5	0	Gain	1 to 5	
40	1	Measurement surface of area 1	0: 1st surface 1: 2nd surface 2: 3rd surface	Parameters for area 1 at Glass thickness/Gap measurement by moving the objects. To refer to or set the parameters for area 2, add 20 to the unit No. (*)
	32	Measurement value of area 1 (1st surface)	- (nm)	
	33	Measurement value of area 1 (2nd surface)	- (nm)	
	34	Measurement value of area 1 (3rd surface)	- (nm)	
41	0	Scaling mode	0: OFF 1: ON	
	1	Span value	-20000 to 20000 (1 div: 0.0001)	
	2	Offset value	-999999999 to 999999999 (nm)	
42	2	Smooth	0: OFF 1: ON	
43	2	Average	0: 1 time 1: 2 times 2: 4 times 3: 8 times 4: 16 times 5: 32 times 6: 64 times 7: 128 times 8: 256 times 9: 512 times 10: 1024 times 11: 2048 times 12: 4096 times	

Unit No.	Data No.	Parameter	Setting range/Output range	Others
44	2	Differential	0: OFF 1: ON	
	3	Differentiation cycles	1 to 5000 (ms)	
45	2	Hold type	0: OFF 1: PEAK 2: BOTTOM 3: P-P 4: AVERAGE 5: SAMPLE	
	3	Trigger method	0: EXT 1: SELF-UP 2: SELF-DOWN	
	4	Trigger level	-999999999 to 999999999 (nm)	
	5	Trigger hysteresis	0 to 999999999 (nm)	
	6	Trigger delay (ms)	0 to 5000 (ms)	
	7	Sampling period (ms)	1 to 5000 (ms)	
	8	Trigger delay mode	0: OFF 1: ON	
	46	5	Offset at zero reset	
6		Zero reset mode	0: REAL 1: HOLD	
120	0	Non-measurement settings	0: KEEP 1: CLAMP	
	1	Output at CLAMP	0: MAX 1: 20mA 2: 12mA 3: 4mA 4: MIN	
121	0	Hysteresis width	0 to 999999999 (nm)	Setting judgment process
	1	Timer mode	0: OFF 1: OFF DELAY 2: ON DELAY 3: ONE SHOT	
	2	Delay time	1 to 5000 (ms)	
122	2	Monitor focus mode	0: OFF 1: ON	
	3	Monitor focus distance value 1	-999999999 to 999999999 (nm)	
	4	Monitor focus distance value 2	-999999999 to 999999999 (nm)	
	5	Monitor focus current value 1	4 to 20 (mA)	
	6	Monitor focus current value 2	4 to 20 (mA)	
	7	Monitor focus voltage value 1	-10 to 10 (V)	
	8	Monitor focus voltage value 2	-10 to 10 (V)	

List of Parameters (ZS-LDC)

Unit No.	Data No.	Parameter	Setting range/Output range	Others
126	4	External input 0 ActiveSelect	0: Low Active 1: High Active	
	5	External input 1 ActiveSelect		
	6	External input 2 ActiveSelect		
	7	External input 3 ActiveSelect		
	8	External input mode	0: Standard mode 1: Bank switching mode 2: Parallel IN off mode	
	9	Control TASK setting	0: TASK1 1: TASK2 2: TASK3 3: TASK4	
127	0	External input (IN) task mode	0: None 1: TASK1 2: TASK2 3: TASK3 4: TASK4 5: TASKALL	
	1	External input (IN) function mode	0: Standard 1: Bank	
	2	External output (OUT) task mode	0: None 1: TASK1 2: TASK2 3: TASK3 4: TASK4	
	4	Linear output task mode	0: None 1: TASK1 2: TASK2 3: TASK3 4: TASK4	
	6	Digital output target	0: OFF 1: ON	
	10	External input 0 mode	0: Not used	
	11	External input 1 mode	1: Trigger	
	12	External input 2 mode	2: Hold reset	
13	External input 3 mode	3: Laser off 4: Zero reset		

(*)

When [Glass thickness/Gap-Film/Else-Move] is selected, task processes similar to those of ZS-MDC are performed internally.

The following processes are assigned to respective tasks:

TASK 1	Calculates Area 1 displacement value.
TASK 2	Calculates Area 2 displacement value.
TASK 3	Calculates the difference value (=Thickness/Gap) between TASK1 and TASK2.
TASK 4	Unused

The measurement conditions can be set for each task in this mode.

Setting Threshold Value

- A mode other than [Glass thickness/Gap-Film/Else-Move] is selected.

Unit No.	Data No.	Parameter	Setting range/Output range	Others
48	2	Lower limit of threshold	-999999999 to 999999999 (nm)	
	3	Upper limit of threshold	-999999999 to 999999999 (nm)	
	4	Hysteresis width	0 to 999999999 (nm)	
	5	Timer mode	0:OFF 1:OFF DELAY 2:ON DELAY 3:ONE SHOT	
	6	Delay time	1 to 5000 (ms)	

- [Glass thickness/Gap-Film/Else-Move] is selected.

Unit No.	Data No.	Parameter	Setting range/Output range	Others
88	2	Lower limit of threshold	-999999999 to 999999999 (nm)	
	3	Upper limit of threshold	-999999999 to 999999999 (nm)	
	4	Hysteresis width	0 to 999999999 (nm)	
	5	Timer mode	0:OFF 1:OFF DELAY 2:ON DELAY 3:ONE SHOT	
	6	Delay time	1 to 5000 (ms)	

List of Parameters (ZS-HLDC)

The following parameters can be obtained or set by DATASET or DATAGET command:

Unit No.	Data No.	Parameter	Setting range/Output range	Others
0	0	Measurement mode	0: STANDARD 1: HI-RESO 2: HI-SPEED 3: HI-SENS 4: CUSTOM	When multi-task mode is OFF.
		Measurement mode	1: STANDARD 2: HI-RESO 3: HI-SENS 4: CUSTOM	When multi-task mode is ON.
	12	Start position of area 1	0 to 639 (pix)	
	14	End position of area 1	0 to 639 (pix)	
	13	Start line of area 1	0 to (No. of additional lines - 1)	
	15	End line of area 1	0 to (No. of additional lines - 1)	
	24	Start position of area 2	0 to 639 (pix)	
	26	End position of area 2	0 to 639 (pix)	
	25	Start line of area 2	0 to (No. of additional lines - 1)	
	27	End line of area 2	0 to (No. of additional lines - 1)	
	18	Exposure time	2 to 200 (1 div: 0.1ms) When multi-task mode is OFF. 5 to 200 (1 div: 0.1ms) When multi-task mode is ON.	Parameters for CUSTOM mode
	19	Number of additional lines	1 to 200 When multi-task mode is OFF.	
			8 to 200 When multi-task mode is ON.	
	20	Line skipping	0: OFF 1: ON	
	22	2-area mode	0: OFF 1: ON	
	23	Compensation mode	0: OFF 1: Start position compensation 2: End position compensation 3: Start/End position compensation	
32	Measurement cycle	112 to 20000 (us)		
192	Reference point teach for compensation mode	1: Execute teach		
193	2-area teach	1: Execute teach		
1	0	Head installation	0: Diffuse 1: Regular	
2	0	LD power mode	0: Auto 1: Auto-scale 2: Fixed	
	2	Surface to be controlled for light amount	0: Peak 1: First surface 2: Second surface 3: Third surface	

List of Parameters (ZS-HLDC)

Unit No.	Data No.	Parameter	Setting range/Output range	Others
2	6	LD power when fixed	0 to 800 (1 div: 0.1%)	
	13	Lower limit of LD power	0 to 800 (1 div: 0.1%)	
	14	Upper limit of LD power	0 to 800 (1 div: 0.1%)	
	32	Incident level	0 to 4095	
	36	LD power	0 to 800 (1 div: 0.1%)	
	37	Incident level (First surface)	0 to 4095	
	38	Incident level (Second surface)	0 to 4095	
	39	Incident level (Third surface)	0 to 4095	
3	0	Measurement object	0: Normal 1: PCB 2: Mirror 3: Glass 4: Glass thickness	
	2	GLASS/GLASS THICKNESS mode	0: Mode 1 1: Mode 2	
	3	Image smoothing level	0: No filter 1: Filter size 2 2: Filter size 4 3: Filter size 8 4: Filter size 16	When the measurement object is changed, the settings are initialized according to the selected object.
	4	Background removing level before addition	0 to 255 (tone)	
	6	Edge threshold	0: 0% 1: 12.5% 2: 25% 3: 37.5% 4: 50% 5: 62.5% 6: 75% 7: 87.5%	
4	0	Mutual interference prevention mode	0: OFF 1: ON	
	1	Mutual interference prevention timing	0: Timing A 1: Timing B	
5	0	Gain setting	1 to 5	

List of Parameters (ZS-HLDC)

Unit No.	Data No.	Parameter	Setting range/Output range	Others
40	0	Measurement mode	0: OFF 1: Average 2: Peak 3: Bottom 4: Thickness 5: Gap 6: K+mX; +nY	TASK1 settings. The settings in Unit Number 40 are valid only for multi-task mode.
	3	Parameter X	0: None 1: TASK 1 2: TASK 2 3: TASK 3 4: TASK 4	
	4	Parameter Y	0: None 1: TASK 1 2: TASK 2 3: TASK 3 4: TASK 4	
	5	Parameter K	-999999999 to 999999999 (nm)	
	8	Parameter M	-100 to 100 (1div: 0.1)	
	9	Parameter N	-100 to 100 (1div: 0.1)	
	1	Surface for measurement (Area 1)	0: First surface 1: Second surface 2: Third surface	
	10	Surface for measurement (Area 2)	0: First surface 1: Second surface 2: Third surface	
	11	Measurement position 1 (for thickness measurement)	0: None 1: Average 2: Peak 3: Bottom	
	12	Measurement position 2 (for thickness measurement)	0: None 1: Average 2: Peak 3: Bottom	
	13	Measurement area	0: Area 1 1: Area 2	
	14	Width of peak bottom	0 to 255	
	32	Measurement value (First surface)	- (nm)	
	33	Measurement value (Second surface)	- (nm)	
34	Measurement value (Third surface)	- (nm)		
41	0	Scaling mode	0: OFF 1: ON	
	1	Span value	-20000 to 20000 (1 div: 0.0001)	
	2	Offset value	-999999999 to 999999999 (nm)	
42	2	Smooth	0: OFF 1: ON	

Unit No.	Data No.	Parameter	Setting range/Output range	Others
43	2	Average	0: 1 time	TASK1 settings. The settings in Unit Number 40 are valid only for multi-task mode.
			1: 2 times	
			2: 4 times	
			3: 8 times	
			4: 16 times	
			5: 32 times	
			6: 64 times	
			7: 128 times	
			8: 256 times	
			9: 512 times	
			10: 1024 times	
			11: 2048 times	
12: 4096 times				
44	2	Differential type	0: OFF 1: ON	
	3	Differentiation cycles	1 to 5000 (ms)	
45	2	Hold type	0: Through	
			1: Peak	
	2: Bottom			
	3: Peak to peak			
	4: Average			
	5: Sampling			
	3	Trigger method	0: External input 1: Self up 2: Self down	
	4	Trigger level	-999999999 to 999999999 (nm)	
5	Trigger hysteresis	0 to 999999999 (nm)		
6	Trigger delay (ms)	0 to 5000 (ms)		
7	Sampling period (ms)	1 to 5000 (ms)		
8	Trigger delay mode	0: OFF 1: ON		
46	5	Offset at zero reset	-999999999 to 999999999 (nm)	
	7	Zero reset mode	0: REAL 1: HOLD	
	64	Status	0: OFF 1: ON	

(*)

If GLASS/MODE 2 or GLASS THICKNESS/MODE 2 is selected, a process using multiple tasks will be performed, as in the multi-task mode.

The following processes are assigned to the respective tasks:

TASK 1	Calculates Area 1 displacement value.
TASK 2	Calculates Area 2 displacement value.
TASK 3	GLASS: Calculates the result of the NEAR side of TASK 1 and TASK 2.
	GLASS THICKNESS: Calculates the difference value between TASK1 and TASK2.
TASK 4	Unused

List of Parameters (ZS-HLDC)

The measurement conditions can be set for each task in this mode.

- Configuration of Task

The ZS-HLDC performs task processing.

The processing units for each task are grouped into 20 units.

To refer to the processing unit of TASK N, therefore, add $20 \times (N-1)$ to the above processing unit No.

Example: To change the averaging process of TASK2, refer to or set to a parameter with:

Process unit No.= $43+20 \times (2-1)=63$ and

Data No.=2

Unit No.	Data No.	Parameter	Setting range/Output range	Others
120	0	Hysteresis width	0 to 999999999 (nm)	Setting judgment process
	1	Timer mode	0: OFF 1: OFF-Delay 2: ON-Delay 3: One shot	
	2	Delay time	1 to 5000 (ms)	
	3	Judgment output TASK	0: TASK 1 1: TASK 2 2: TASK 3 3: TASK 4	
121	0	Non-measurement settings	0: Keep 1: Clamp	
122	2	Monitor focus mode	0: OFF 1: ON	
	3	Monitor focus distance value 1	-999999999 to 999999999 (nm)	
	4	Monitor focus distance value 2	-999999999 to 999999999 (nm)	
	5	Monitor focus current value 1	4 to 20 (mA)	
	6	Monitor focus current value 2	4 to 20 (mA)	
	7	Monitor focus voltage value 1	-10 to 10 (V)	
	8	Monitor focus voltage value 2	-10 to 10 (V)	
	21	Output mode TASK	When multi-task mode is OFF. 0: OFF 1: ON When multi-task mode is ON. 0: OFF 1: TASK 1 2: TASK 2 3: TASK 3	

Unit No.	Data No.	Parameter	Setting range/Output range	Others
122	23	Output at CLAMP	Voltage output 0: MAX 1: 10 V 2: 9 V 3: 8 V 4: 7 V 5: 6 V 6: 5 V 7: 4 V 8: 3 V 9: 2 V 10: 1 V 11: 0 V 12: -1 V 13: -2 V 14: -3 V 15: -4 V 16: -5 V 17: -6 V 18: -7 V 19: -8 V 20: -9 V 21: -10 V 22: MIN	
			Current output 0: MAX 1: 20 mA 2: 19 mA 3: 18 mA 4: 17 mA 5: 16 mA 6: 15 mA 7: 14 mA 8: 13 mA 9: 12 mA 10: 11 mA 11: 10 mA 12: 9 mA 13: 8 mA 14: 7 mA 15: 6 mA 16: 5 mA 17: 4 mA	
123 Digital output	2	Monitor focus mode	0: OFF 1: ON	
	3	Monitor focus distance value 1	-999999999 to 999999999 (nm)	
	4	Monitor focus distance value 2	-999999999 to 999999999 (nm)	
	5	Monitor focus current value 1	0 to 65535	
	6	Monitor focus current value 2	0 to 65535	
	7	Clear monitor focus	1: Clear	

List of Parameters (ZS-HLDC)

Unit No.	Data No.	Parameter	Setting range/Output range	Others
123	8	Output at CLAMP	0 to 65535	
	10	Output TASK (When the measurement value is output)	0: TASK 1 1: TASK 2 2: TASK 3 3: TASK 4 4: Consecutively	
	11	Output mode	0: OFF 1: Measurement value 2: Judgment	
	12	Update cycle	0 to 100	
124 Logging	2	Mode	0: OFF 1: ON	
	3	Buffering period	1 to 65535	
	4	Buffer size per item of data	1 to 1000	
	14	TASK 1	0: OFF 1: ON	When multi-task mode is ON.
	15	TASK 2	0: OFF 1: ON	
	16	TASK 3	0: OFF 1: ON	
	17	TASK 4	0: OFF 1: ON	
126 Link	0	Output TASK	0: TASK 1 1: TASK 2 2: TASK 3 3: TASK 4	
	6	Mode	0: OFF 1: ON	
240 Parallel input	4	Input 0	0: Low Active 1: High Active	
	5	Input 1		
	6	Input 2		
	7	Input 3		
	8	External input mode	0: Normal mode 1: Bank switching mode 2: Parallel IN off mode	
	9	Control TASK setting	0: TASK1 1: TASK2 2: TASK3 3: TASK4	

Setting Threshold Value

When multi-task mode is OFF

- When selecting a mode other than "GLASS/MODE 2" and "GLASS THICKNESS/MODE 2".

Unit No.	Data No.	Parameter	Setting range/Output range	Others
48	2	Lower limit of threshold	-999999999 to 999999999 (nm)	
	3	Upper limit of threshold	-999999999 to 999999999 (nm)	
	4	Hysteresis width	0 to 999999999 (nm)	
	5	Timer mode	0:OFF 1:OFF DELAY 2:ON DELAY 3:ONE SHOT	
	6	Delay time	1 to 5000 (ms)	

- When selecting "GLASS/MODE 2" or "GLASS THICKNESS/MODE 2" mode.

Unit No.	Data No.	Parameter	Setting range/Output range	Others
88	2	Lower limit of threshold	-999999999 to 999999999 (nm)	
	3	Upper limit of threshold	-999999999 to 999999999 (nm)	
	4	Hysteresis width	0 to 999999999 (nm)	
	5	Timer mode	0:OFF 1:OFF DELAY 2:ON DELAY 3:ONE SHOT	
	6	Delay time	1 to 5000 (ms)	

When multi-task mode is ON

- Can be set for each TASK.

Unit No.	Data No.	Parameter	Setting range/Output range	Others
48	2	Lower limit of threshold	-999999999 to 999999999 (nm)	TASK1 settings. For TASK2 to TASK4, the unit numbers are as follows: TASK2: 68 TASK3: 88 TASK4: 108
	3	Upper limit of threshold	-999999999 to 999999999 (nm)	
	4	Hysteresis width	0 to 999999999 (nm)	
	5	Timer mode	0:OFF 1:OFF DELAY 2:ON DELAY 3:ONE SHOT	
	6	Delay time	1 to 5000 (ms)	

List of Parameters (ZS-MDC)

The following parameters can be acquired or set by DATASET or DATAGET command:

Unit No.	Data No.	Parameter	Setting range/Output range	Others
0	0	Destination CH to input data A	0 to 11 (CH)	
	1	Destination CH to input data B	0 to 11 (CH)	
	2	Destination CH to input data C	0 to 11 (CH)	
	3	Destination CH to input data D	0 to 11 (CH)	
	4	Destination CH to input data E	0 to 11 (CH)	
	5	Destination CH to input data F	0 to 11 (CH)	
	6	Destination CH to input data G	0 to 11 (CH)	
	7	Destination CH to input data H	0 to 11 (CH)	
	8	Destination CH to input data I	0 to 11 (CH)	
	9	Input mode of data A	0: OFF 1: ON	
	10	Input mode of data B	0: OFF 1: ON	
	11	Input mode of data C	0: OFF 1: ON	
	12	Input mode of data D	0: OFF 1: ON	
	13	Input mode of data E	0: OFF 1: ON	
	14	Input mode of data F	0: OFF 1: ON	
	15	Input mode of data G	0: OFF 1: ON	
	16	Input mode of data H	0: OFF 1: ON	
	17	Input mode of data I	0: OFF 1: ON	
	32	Acquisition result A	-999999999 to 999999999 (nm)	
	33	Acquisition result B	-999999999 to 999999999 (nm)	
	34	Acquisition result C	-999999999 to 999999999 (nm)	
35	Acquisition result D	-999999999 to 999999999 (nm)		
36	Acquisition result E	-999999999 to 999999999 (nm)		
37	Acquisition result F	-999999999 to 999999999 (nm)		
38	Acquisition result G	-999999999 to 999999999 (nm)		
39	Acquisition result H	-999999999 to 999999999 (nm)		
40	Acquisition result I	-999999999 to 999999999 (nm)		
40	0	Data setting mode	0: OFF 1: Individual 2: Calculation	

Unit No.	Data No.	Parameter	Setting range/Output range	Others
40	1	Individual setting mode	0: Input A 1: Input B 2: Input C 3: Input D 4: Input E 5: Input F 6: Input G 7: Input H 8: Input I	
	2	Calculation setting mode	0: Thickness (K-(X+Y)) 1: Step (X-Y) 2: K+mX+nY 3: AVE 4: MAX-MIN	
	3	Parameter X	0: Input A	
	4	Parameter Y	1: Input B 2: Input C 3: Input D 4: Input E 5: Input F 6: Input G 7: Input H 8: Input I 9: TASK 1 10: TASK 2 11: TASK 3 12: TASK 4	
	5	Parameter K	-999999999 to 999999999 (nm)	
	6	Parameter m	-100 to 100 (×0.1)	
	7	Parameter n	-100 to 100 (×0.1)	
	8	Input A setting (AVE,MAX-MIN)	0: OFF 1: ON	
	9	Input B setting (AVE,MAX-MIN)		
	10	Input C setting (AVE,MAX-MIN)		
	11	Input D setting (AVE,MAX-MIN)		
	12	Input E setting (AVE,MAX-MIN)		
	13	Input F setting (AVE,MAX-MIN)		
	14	Input G setting (AVE,MAX-MIN)		
	15	Input H setting (AVE,MAX-MIN)		
	16	Input I setting (AVE,MAX-MIN)		
	17	TASK1 setting (AVE,MAX-MIN)		

List of Parameters (ZS-MDC)

Unit No.	Data No.	Parameter	Setting range/Output range	Others
40	18	TASK2 setting (AVE,MAX-MIN)	0: OFF 1: ON	
	19	TASK3 setting (AVE,MAX-MIN)		
	20	TASK4 setting (AVE,MAX-MIN)		
	21	Thickness	-999999999 to 999999999 (nm)	
41	0	Scaling mode	0: OFF 1: ON	
	1	Span value	-20000 to 20000 ($\times 0.0001$)	
	2	Offset value	-999999999 to 999999999 (nm)	
42	2	Smooth	0: OFF 1: ON	
43	2	Average	0: 1 time 1: 2 times 2: 4 times 3: 8 times 4: 16 times 5: 32 times 6: 64 times 7: 128 times 8: 256 times 9: 512 times 10: 1024 times 11: 2048 times 12: 4096 times	
44	2	Differential	0: OFF 1: ON	
	3	Differentiation cycles	1 to 5000 (ms)	
45	2	Hold type	0: OFF 1: PEAK 2: BOTTOM 3: P-P 4: AVERAGE 5: SAMPLE	
	3	Trigger method	0: EXT 1: SELF-UP 2: SELF-DOWN	
	4	Trigger level	-999999999 to 999999999 (nm)	
	5	Trigger hysteresis	0 to 999999999 (nm)	
	6	Trigger delay (ms)	0 to 5000 (ms)	
	7	Sampling period (ms)	1 to 5000 (ms)	
	8	Trigger delay mode	0: OFF 1: ON	
46	5	Offset at zero reset	-999999999 to 999999999 (nm)	
	6	Zero reset mode	0: REAL 1: HOLD	

Unit No.	Data No.	Parameter	Setting range/Output range	Others
120	0	Non-measurement settings	0: KEEP 1: CLAMP	
	1	Output at CLAMP	0: MAX	
121	0	Hysteresis width	0 to 999999999 (nm)	
	1	Timer mode	0: OFF 1: OFF DELAY 2: ON DELAY 3: ONE SHOT	
	2	Delay time	1 to 5000 (ms)	
122	2	Monitor focus mode	0: OFF 1: ON	
	3	Monitor focus distance value 1	-999999999 to 999999999 (nm)	
	4	Monitor focus distance value 2	-999999999 to 999999999 (nm)	
	5	Monitor focus current value 1	4 to 20 (mA)	
	6	Monitor focus current value 2	4 to 20 (mA)	
	7	Monitor focus voltage value 1	-10 to 10 (V)	
	8	Monitor focus voltage value 2	-10 to 10 (V)	
	125	4	External input 0 ActiveSelect	0: Low Active 1: High Active
5		External input 1 ActiveSelect		
6		External input 2 ActiveSelect		
7		External input 3 ActiveSelect		
8		External input mode	0: Standard mode 1: Bank switching mode 2: ParallelIN off mode	
9		Control TASK setting	0: TASK1 1: TASK2 2: TASK3 3: TASK4	
126		0	External input (IN) task mode	0: None 1: TASK1 2: TASK2 3: TASK3 4: TASK4 5: TASKALL
	1	External input (IN) function mode	0: Standard 1: Bank	

List of Parameters (ZS-MDC)

Unit No.	Data No.	Parameter	Setting range/Output range	Others
126	2	External output (OUT) task mode	0: None 1: TASK1 2: TASK2 3: TASK3 4: TASK4	
	4	Linear output task mode	0: None 1: TASK1 2: TASK2 3: TASK3 4: TASK4	
	6	Digital output target	0: OFF 1: ON	
	10	External input 0 mode	0: Not used	
	11	External input 1 mode	1: Trigger	
	12	External input 2 mode	2: Hold reset 3: Laser off	
	13	External input 3 mode	4: Zero reset	

- Configuration of Task

The ZS-MDC performs task processing. The processing units for each task are grouped into 20 units. To refer to the processing unit of TASK N, therefore, add $20 \times (N-1)$ to the above processing unit No.

Example: To change the averaging process of TASK2, refer to or set to a parameter with:

Process unit No.= $43+20 \times (2-1)=63$ and

Data No.=2

Setting Threshold Value

- In case of TASK1

Unit No.	Data No.	Parameter	Setting range/Output range	Others
48	2	Lower limit of threshold	-999999999 to 999999999 (nm)	
	3	Upper limit of threshold	-999999999 to 999999999 (nm)	
	4	Hysteresis width	0 to 999999999 (nm)	
	5	Timer mode	0: OFF 1: OFF DELAY 2: ON DELAY 3: ONE SHOT	
	6	Delay time	1 to 5000 (ms)	



To change the threshold of TASKN, change the unit No. as follows:

Unit No.= $48+20 \times (N-1)$

CHECK!

List of Parameters (ZS-DSU)

The following parameters can be obtained or set by DATASET or DATAGET command:

Unit No.	Data No.	Parameter	Setting range/Output range	Others
0	0	Input CH to Source A	0: 1CH	
	1	Input CH to Source B	1: 2CH	
	2	Input CH of Source C	2: 3CH	
	3	Input CH to Source D	3: 4CH	
	4	Input CH to Source E	4: 5CH	
	5	Input CH to Source F	5: 6CH	
	6	Input CH to Source G	6: 7CH	
	7	Input CH to Source H	7: 8CH	
	8	Input CH to Source I	8: 9CH	
	9	Input CH of Source J	9: 10CH	
	10	Input CH of Source K	:	
	11	Input CH of Source L	13: 14CH	
	12	Input CH of Source M		
	13	Input CH of Source N		
	14	Selected TASK of Source A	0: TASK1	Valid when the connected controller is a ZS-MDC.
	15	Selected TASK of Source B	1: TASK2	
	16	Selected TASK of Source C	2: TASK3	
	17	Selected TASK of Source D	3: TASK4	
	18	Selected TASK of Source E	4: InputA	
	19	Selected TASK of Source F	5: InputB	
	20	Selected TASK of Source G	:	
	21	Selected TASK of Source H	13: InputI	
	22	Selected TASK of Source I		
	23	Selected TASK of Source J		
	24	Selected TASK of Source K		
	25	Selected TASK of Source L		
	26	Selected TASK of Source M		
	27	Selected TASK of Source N		

List of Parameters (ZS-DSU)

Unit No.	Data No.	Parameter	Setting range/Output range	Others
0	28	Save mode of Source A	0: OFF 1: ON	
	29	Save mode of Source B		
	30	Save mode of Source C		
	31	Save mode of Source D		
	32	Save mode of Source E		
	33	Save mode of Source F		
	34	Save mode of Source G		
	35	Save mode of Source H		
	36	Save mode of Source I		
	37	Save mode of Source J		
	38	Save mode of Source K	0: OFF 1: ON	
	39	Save mode of Source L		
	40	Save mode of Source M		
	41	Save mode of Source N		
	64	Acquisition result A	-999999999 to 999999999 (nm)	
	65	Acquisition result B		
	66	Acquisition result C		
	67	Acquisition result D		
	68	Acquisition result E		
	69	Acquisition result F		
70	Acquisition result G			
71	Acquisition result H			
72	Acquisition result I			
73	Acquisition result J			
74	Acquisition result K			
75	Acquisition result L			
76	Acquisition result M			
77	Acquisition result N			
1	0	Start trigger mode	0: None 1: External input 2: Data 3: Window 4: I/O 5: HOUR	
	1	Start trigger Trigger edge polarity	0: Up trigger 1: Down trigger	
	2	Start trigger Data selection	0: Source A 1: Source B : 13: Source N	
	3	Start trigger Delay	-9999 to 9999 (ms) (*1) -127 through 127 (Number of images) (*2)	(*1) [Save image] is set to OFF. (*2) [Save image] is set to ON.
	4	Start trigger Data threshold	-999999999 to 999999999 (nm)	

Unit No.	Data No.	Parameter	Setting range/Output range	Others
1	6	Start trigger Window mode	0: WindowIn 1: WindowOut	
	7	Start trigger Window upper limit	-999999999 to 999999999 (nm)	
	8	Start trigger Window upper limit	-999999999 to 999999999 (nm)	
	10	Start trigger Pattern of I/O I/O selection	0: IN0 1: IN1 2: IN2 3: IN3 4: OUT0 5: OUT1 6: OUT2 7: OUT3 8: OUT4	
	12	End trigger mode	0: BUTTON 1: EXT 2: DATA 3: WINDOW 4: I/O 5: HOUR 6: QUANT 7: TIME	When [Save image] is set to ON, [TIME] is not available.
	13	End trigger Trigger edge polarity	Same as Start trigger	
	14	End trigger Data selection	Same as Start trigger	
	15	End trigger Data threshold		
	17	End trigger Window mode		
	18	End trigger Window upper limit		
19	End trigger Window lower limit			
21	End trigger Pattern of I/O I/O selection			
24	End trigger Logging data points	1 through 999999 (*1) 1 through 128 (*2)		(*1) [Save image] is set to OFF. (*2) [Save image] is set to ON.
2	0	Save mode	0: OneShot 1: Repeat	When [Save image] is set to ON, [REPEAT] is not available.
	1	Repeat mode	0: New 1: ADD 2: OVER WR	When [Save image] is set to ON, [ADD] is not available.
	2	Repeat end conditions	0: None 1: Trigger times 2: Elapsed time (timeout)	

List of Parameters (ZS-DSU)

Unit No.	Data No.	Parameter	Setting range/Output range	Others
2	3	Repeat end conditions Trigger times	1 to 100000 (pcs)	It is available only if [Save image] is set to ON.
	6	Interval of saving image	0: All 1: Save NG	
	7	NG save mode	0: OR 1: AND	
	8	Save image mode	0: Standard 1: Latest	
3	1	I/O data	0: No save 1: Save	
	2	Save direction (Range)	0: COLUMN 1: ROW	
	3	New line input	0: Ignore 1: Enable	



CHECK!

Label input and time settings can not be set or referenced.

Judgment relation

Unit No.	Data No.	Parameter	Setting range/Output range	Others
40	0	Input source	0: Source A 1: Source B 2: Source C 3: Source D 4: Source E 5: Source F 6: Source G 7: Source H 8: Source I 9: Source J 10: Source K 11: Source L 12: Source M 13: Source N	
	1	Lower limit of threshold	-999999999 to 999999999 (nm)	
	2	Upper limit of threshold	-999999999 to 999999999 (nm)	

For Image Logging

Unit No.	Data No.	Parameter	Setting range/Output range	Others
20	0	Align image	0: None 1: 1CH 2: 2CH : 14: 14CH	
	1	Save image	0: OFF 1: ON	

FLOWDATA Reference

What is FLOWDATA?

The ZS series implements high speed sampling measurement up to 110us.

Handling these measurement data with an external device requires reading in a large amount of data.

The ZS series are provided with a mechanism which enables to handle and acquire measurement data by a given bundle.

This bundle of data is called a FLOWDATA.

How to acquire FLOWDATA

FLOWDATA is batch output if the controller has accepted the command for acquiring a FLOWDATA when data is accumulated for the specified buffer size (max. 1000 data).

A device receiving data (such as PC) needs to issue the command before the ZS controller accumulates measurement data for the buffer size.

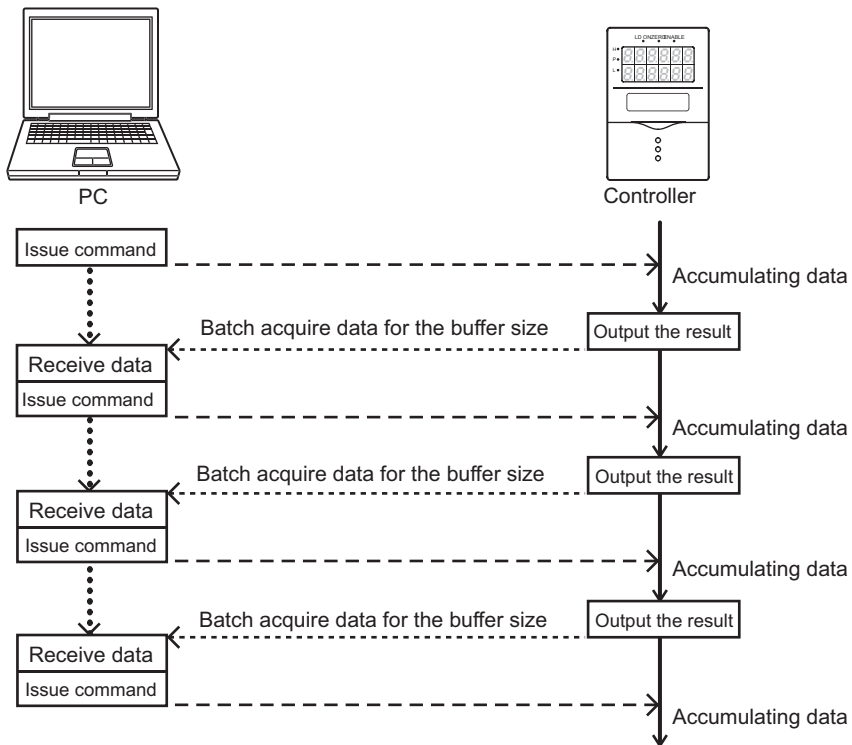

If the controller has not received the command when measurement data for the buffer size is accumulated in the controller, the past data is overwritten:

In this case, it raises an error flag for buffer overflow. A device receiving data (such as PC) needs to check this flag to see if the commands have been issued in time.

Format

After outputting the command for acquiring FLOWDATA, the binary data is output in the following format:

Header division (4bytes)	Data division (4bytes)
--------------------------	------------------------



Configuration of FLOWDATA p.34



CHECK!

Binary data is used for response data of FLOWDATA to give the highest priority to the speed. Therefore, general purpose communication tools such as HyperTerminal may not be used to receive the data.

■ Buffer size and buffer intervals

The buffer size of measurement data to be accumulated in the ZS controller and its buffer intervals can be changed.

Change the following parameters:

* DATAGET and DATASET commands are used to change and refer to the parameters.

Unit No.	Data No.	Parameter	Description
124	2	FLOWDATA accumulation mode	0: OFF 1: ON
	3	Buffer intervals	1 to 65535 (pcs)
	4	Buffer size	1 to 1000 (pcs)

■ Logging data

Data to be accumulated in the ZS controller can be selected.

● In case of ZS-LDC

A maximum of 3 data can be accumulated.

Unit No.	Data No.	Parameter	Description
124	5	Accumulated data 1	*
	6	Accumulated data 2	
	7	Accumulated data 3	

* A setting value changes in accordance with the measurement mode.

•[Glass thickness/Gap-Film/Else-Move] is selected.

Value	Description
0	No accumulation
1	Result for area 1
2	Result for area 2
3	Thickness/Gap value

- Glass thickness/Gap except for the above is selected.

Value	Description
0	No accumulation
1	Thickness/Gap value

- A mode other than above is selected.

Value	Description
0	No accumulation
1	Distance value (Measurement value)

● **In case of ZS-HLDC**

- When multi-task mode is OFF
- When GLASS/MODE 2 or GLASS THICKNESS/MODE 2 is selected for the measurement object

Unit No.	Data No.	Value	Description
124	5	0	No accumulation
		1	Accumulation of result of area 1
		2	Accumulation of result of area 2
		3	Accumulation of result of glass surface or glass thickness

- When a mode other than the above is selected for the measurement object

Unit No.	Data No.	Value	Description
124	5	0	No accumulation
		1	Accumulation

- When multi-task mode is ON

Unit No.	Data No.	Value	Description
124	14	0	Does not accumulate the result of TASK 1
		1	Accumulate the result of TASK 1
	15	0	Does not accumulate the result of TASK 2
		1	Accumulate the result of TASK 2
	16	0	Does not accumulate the result of TASK 3
		1	Accumulate the result of TASK 3
	17	0	Does not accumulate the result of TASK 4
		1	Accumulate the result of TASK 4

● In case of ZS-MDC

A maximum of 9 data can be accumulated.

Unit No.	Data No.	Parameter	Description
124	5	Accumulated data 1	0: No accumulation
	6	Accumulated data 2	1: Measurement result of TASK 1
	7	Accumulated data 3	2: Measurement result of TASK 2
	8	Accumulated data 4	3: Measurement result of TASK 3
	9	Accumulated data 5	4: Measurement result of TASK 4
	10	Accumulated data 6	5: Measurement result of Input A
	11	Accumulated data 7	6: Measurement result of Input B
	12	Accumulated data 8	7: Measurement result of Input C
	13	Accumulated data 9	8: Measurement result of Input D
			9: Measurement result of Input E
			10: Measurement result of Input F
			11: Measurement result of Input G
			12: Measurement result of Input H
			13: Measurement result of Input I



Increasing data to be accumulated extends the measurement cycle of the ZS controller. Confirm it by selecting [SYSTEM]-[INFO]-[CYCLE] after setting.

Configuration of FLOWDATA Response

1 packet of FLAWDATA														
Header division												Data division		
1st byte		2nd byte			3rd byte			4th byte				-		
A	B	C	D	E	F	G	H	I	J	K	L	Data	Meaning of data	
8	1	1	2	4	5	1	2	1	1	1	5	32	Number of bits	=Total 64 bits

Details of header division

Data	Name	Description
A	Unused	Reserved bit
B	FLOWDATA overflow bit	Normally set to 0. Set to 1 when there is an overflow in FLOWDATA accumulation.
C	Decimal information	Normally set to 0: 0: nm order, 1: μm order
D	TASK No.	TASK1 to TASK4 (*1)
E	CH No.	CH No. of data source
F	Unit states (Input)	Indicates ON/OFF states of various input lines. (*2)
G	FLOWDATA stop bit	<ul style="list-style-type: none"> All data are set to 1 if FLOWDATA does not flow over subsequently. (Always set to 1 for one-shot requests) All data are set to 0 if FLOWDATA continues to flow over. (Until FLOWDATA is stopped after requested (in succession))
H	TASK judgment result bit	Indicates the TASK judgment result of data source. (*3)
I	Disabled	Reserved bit
J		
K		
L	Unit states (Output)	Indicates output states (states of measurement results). (*4)
Data	Measurement data	Signed 32 bit data When the decimal info division is 0, the unit of the data is nm. When the decimal info division is 1, the unit of the data is μm

*1 TASK No.=bit data+1

Example: bit data=10B=2 (dec)
 indicates TASK3 data.

*2 The input lines are, from the lower bit, assigned to:

In case of ZS

- Input terminal 4 (Unused. Always set to 0.)
- Input terminal 3
- Input terminal 2
- Input terminal 1
- Input terminal 0 (5 inputs in total.)

*3 Data to be received and their states are as follows:

- 00b=Not executed
- 01b=LOW
- 10b=PASS
- 11b=HIGH

*4 The output states are, from the lower bit, assigned to:

In case of ZS

- Output terminal 4 (Busy output)
- Output terminal 3 (Enable output)
- Output terminal 2 (Low output)
- Output terminal 1 (Pass output)
- Output terminal 0 (High output)

(5 outputs in total). States in parenthesis indicate the standard states.

[FLOWDATA setting example]

DATASET 124 2 1 FLOWDATA accumulation mode ON
 DATASET 124 3 1 1 buffer interval
 DATASET 124 4 1 1 buffer size
 DATASET 0 0 1 Input A is 1 CH.
 DATASET 0 1 2 Input B is 2 CH.
 DATASET 0 2 3 Input C is 3 CH.
 DATASET 0 3 4 Input D is 4 CH.

DATASET 124 5 5 Accumulate data 1 is Input A.
 DATASET 124 6 6 Accumulate data 2 is Input B.
 DATASET 124 7 7 Accumulate data 3 is Input C.
 DATASET 124 8 8 Accumulate data 4 is Input D.
 DATASAVE Data save
 FLOWDATA

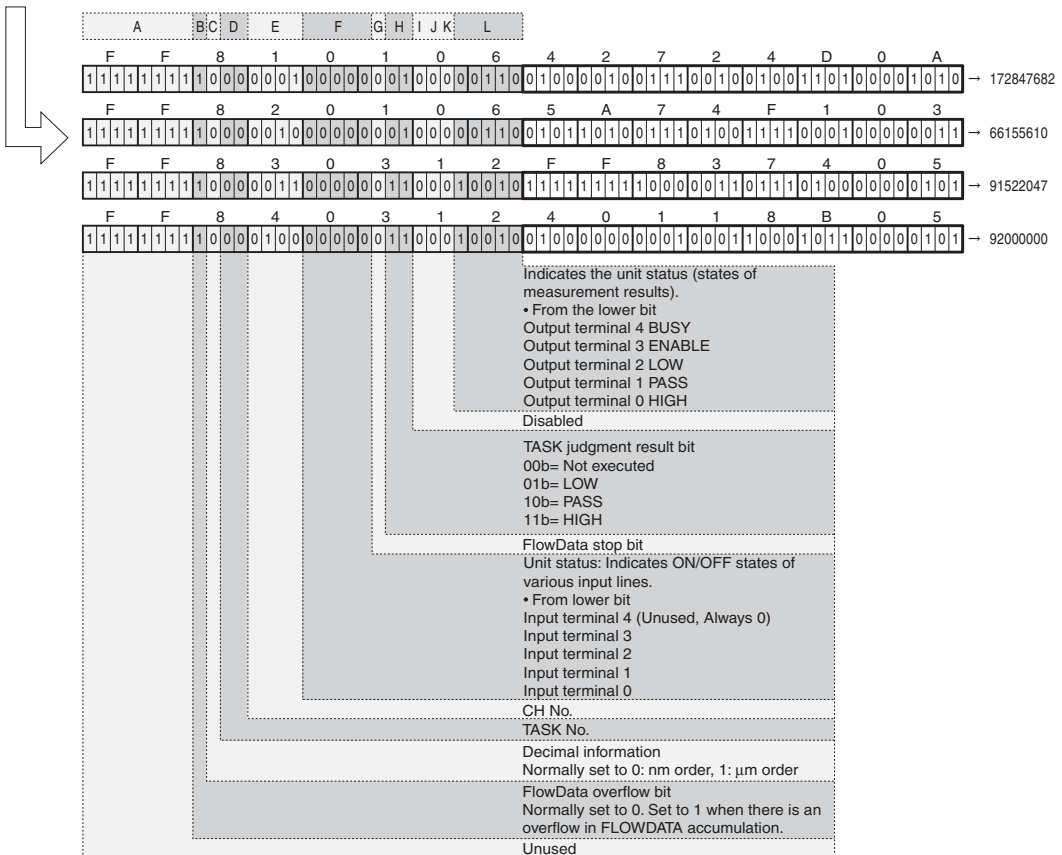

Capturing Image Data

For ZS-DSU (Ver 2.000 or later), image data logging from ZFV is available. Image data on the memory card can be shown as image files (.bmp) by inserting the memory card into the memory slot on the personal computer. Image data can also be imported from the memory card inserted into the ZS-DSU by entering the command below.

Command name	Format
CFIMGGET	CFIMGGET <Group No.> <Logging No.> <delimiter>

- * Group No. is the logging group number that is assigned for each logging trigger.
- * Logging No. is the serial number (logging number) that is assigned during one logging process.
- * Receiving of the image data is performed through the XMODEM communication. (Refer to the next topic.)

* For you reference: Folder tree in the memory card

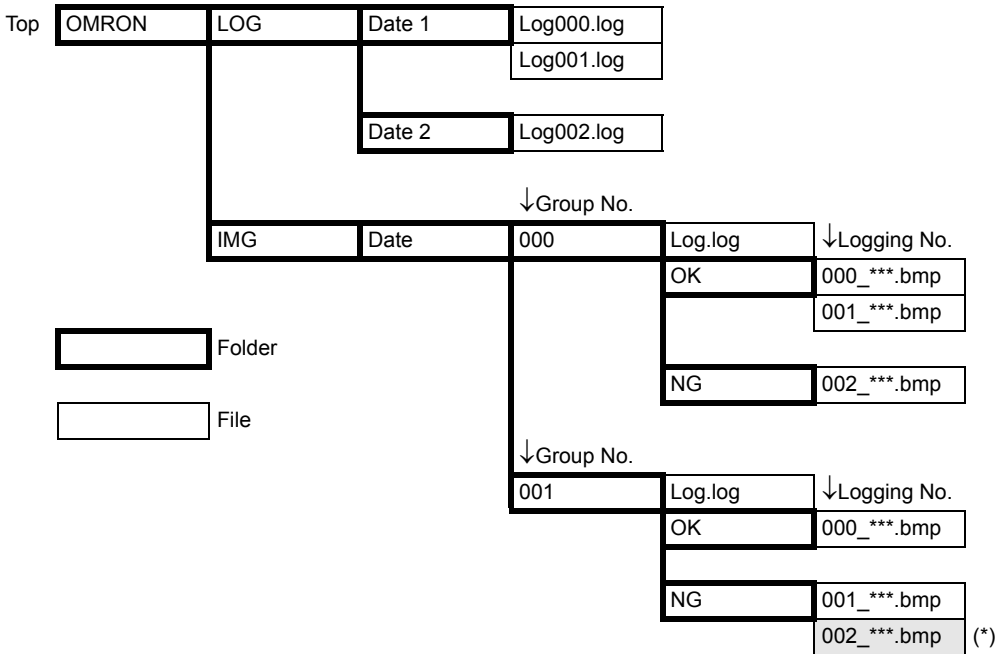

Example:

To read image data with (*) mark, enter the following command.

CFIMGGET 001 002<delimiter>

001 is Group No.

002 is Logging No.

* Numbers must be entered in the 3-digit format.

* Specifying OK/NG folders is not necessary.

Measurement result for the logged image data can also be obtained. Measurement result is stored in the log file in the same group folder. To get the measurement result to the personal computer, enter the following command.

Command name	Format
CFDATGET	CFDATGET <Group No.> <delimiter>

● Flow of XMODEM communication

When you capture image data by entering this command, image data are obtained through XMODEM communication. Communication flow is as follows:

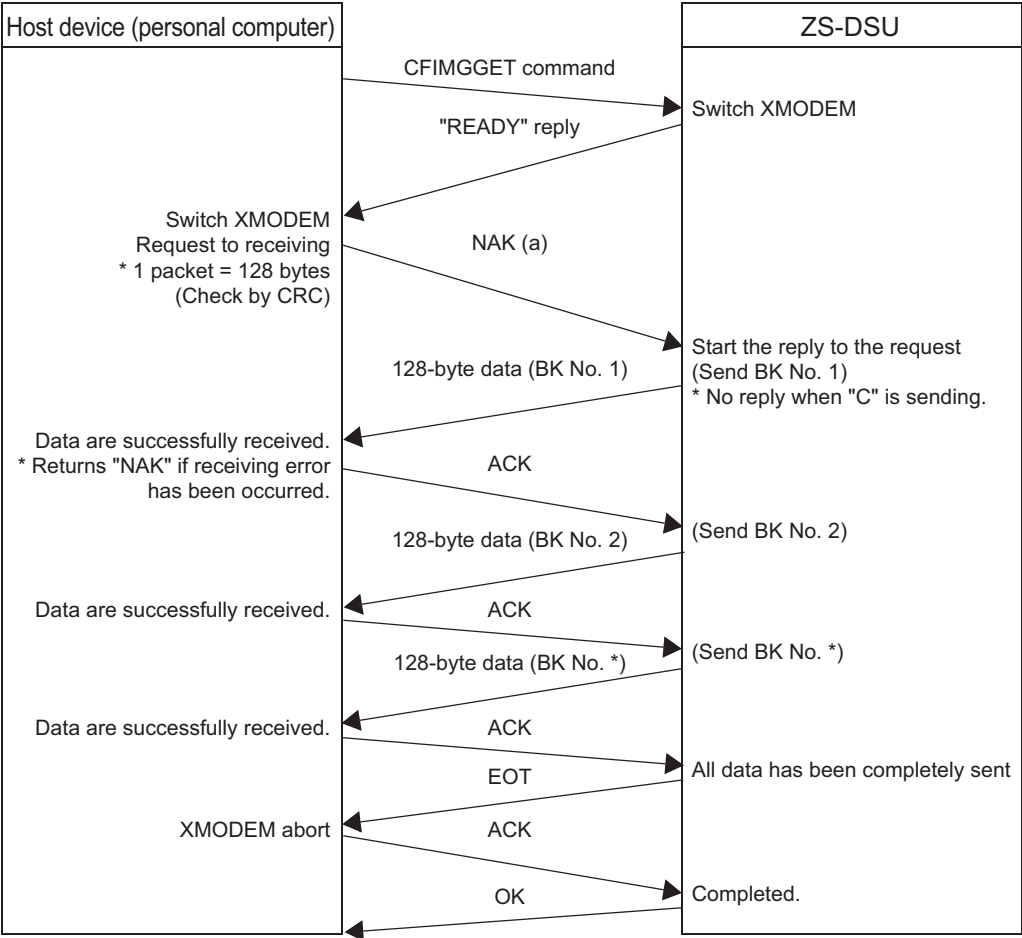
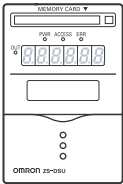

Example of Usage

To give an example, provided below is a procedure to communicate by non-procedural commands using Windows standard tool HyperTerminal.

1. Start up HyperTerminal.

HyperTerminal is located under [Program]-[Accessory]-[Communication].

(1) Enter an appropriate project name.

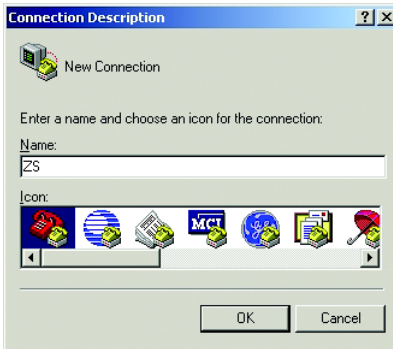

(2) Select the COM port connected to the ZS in the Connection Method section.



(3) Set the communication conditions.

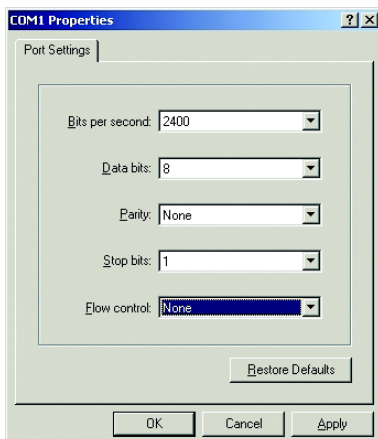

(4) HyperTerminal is started up.

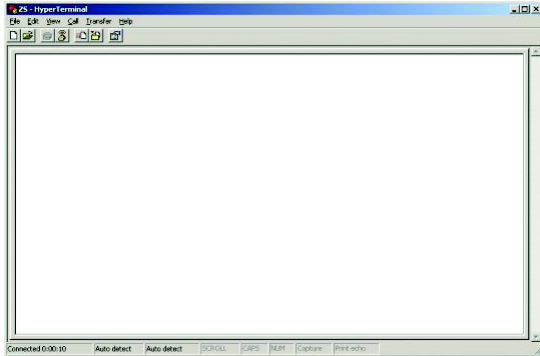

2. To make the interaction with commands easier, set echo and other functions.

(1) Open [Property].

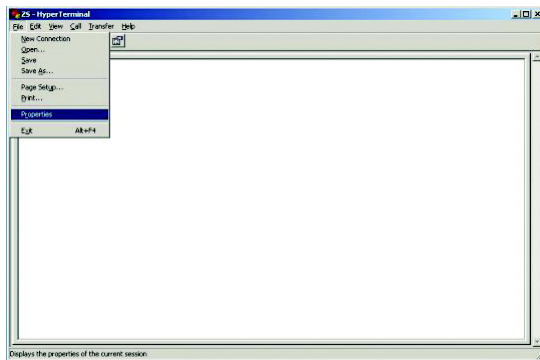

(2) Select the setting tag, and then ASCII settings.

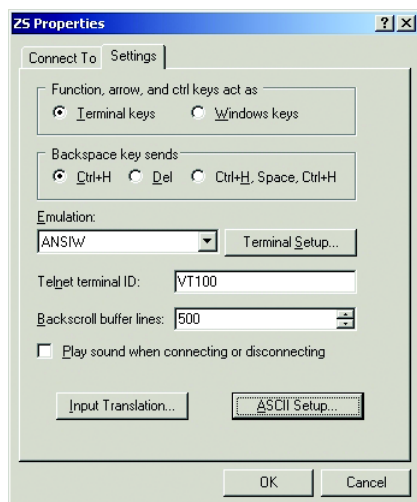

(3) Check the following items, and press OK to complete the setting.

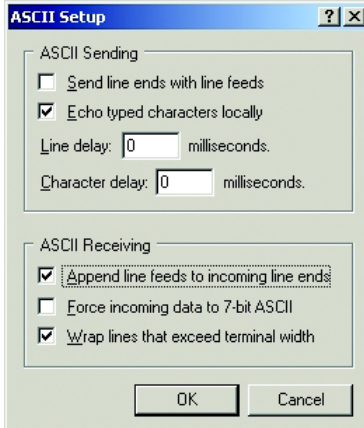

3. Set the communication conditions for the ZS side.

- (1) Set [System]-[Communication]-[RS-232C] as consistent with the above setting.
- (2) Set [System]-[Communication]-[Protocol] as non-procedural.

4. Change ZS into "RUN" mode.

5. Perform non-procedural communication.

- (1) Input a command, and then press the return key.

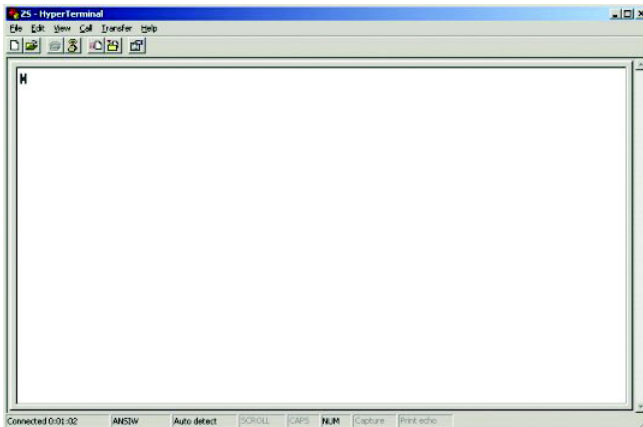

(2) A returned value responding to the command is returned from the controller.

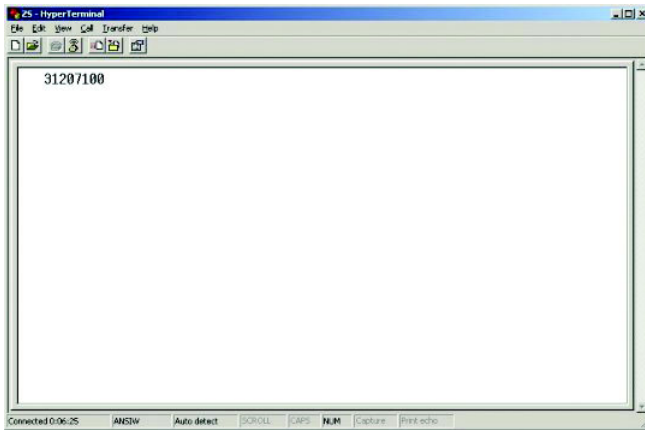

Revision History

Revision Symbol	Revision Date	Description
A	October 2004	First edition
B	June 2005	<ul style="list-style-type: none">• Commands and parameters compatible with ZS-DSU (v2.000) are added.• Multiple controllers connection with ZFV is added.
C	October 2005	<ul style="list-style-type: none">• Commands and parameters compatible with ZS-HLDC is added.